

Date / /



Please draw a circle!



a



C

B

A

b



B

C

F

c



D

C

E

d



F

A

D

e



E

C

A

f



B

F

D



Date / /



Help the bird find her nest! Connect the ABC's!

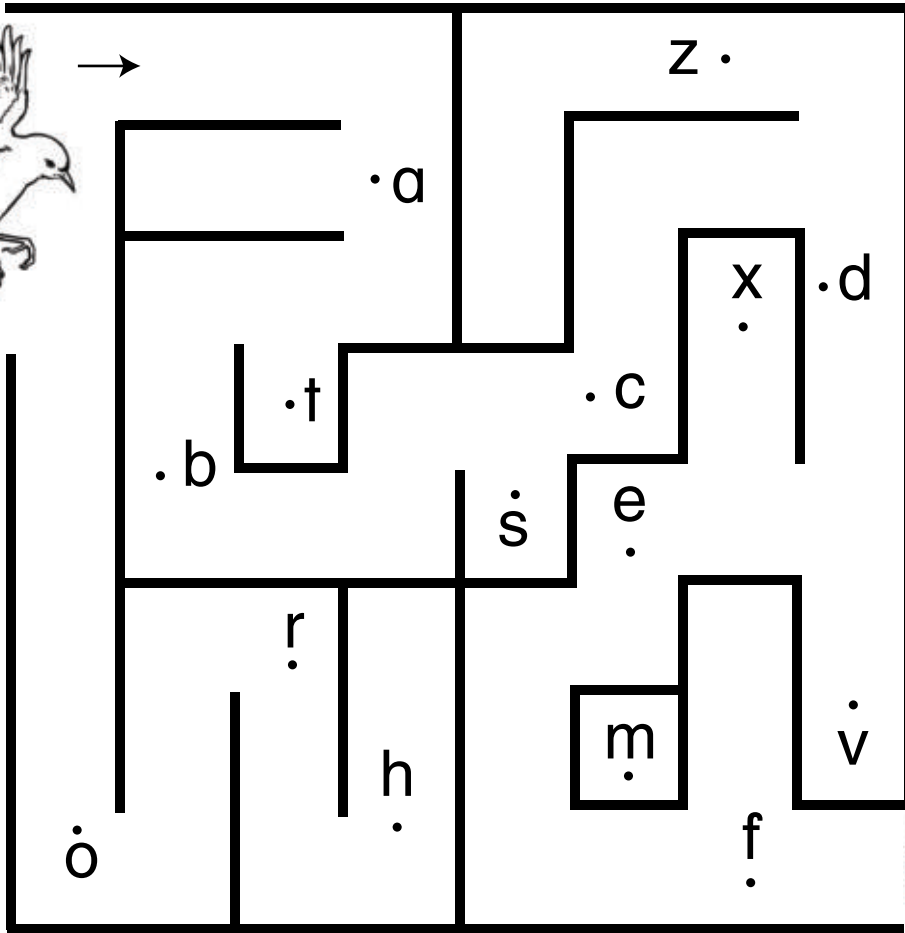
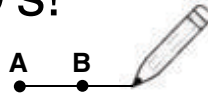

 Fill in the blanks and draw a line!

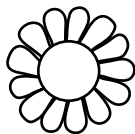



Date / /

Please draw a line!



A

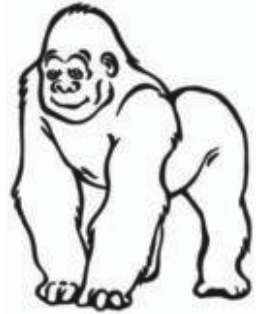
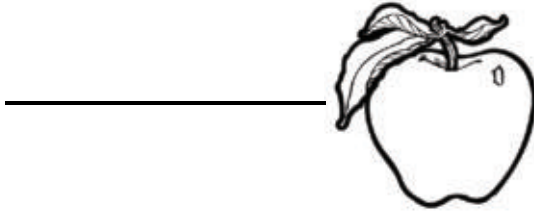

D



F

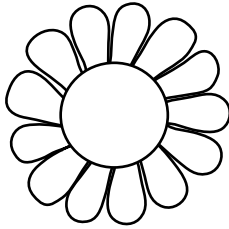

B

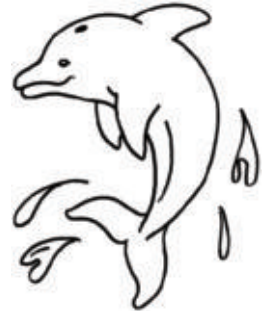

E

C



Please draw a line!

Date	/	/
------	---	---



d



f

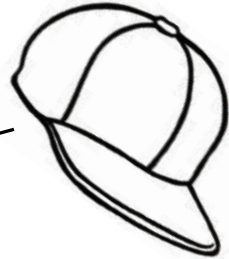

c



a



b

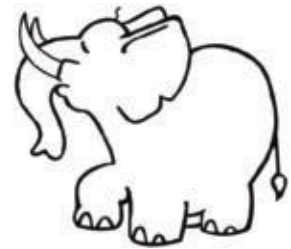

e

